

# Big or small... we fit your space.

ARDSLEY COLLECTION - 39504



## Ardsley Collection



### FEATURES

Master the art of cool, clean-lined style—loaded with sumptuous comfort—with this sectional. Plush and posh, this decidedly contemporary sectional is dressed to impress with wedge-cut track armrests and box cushions for a minimalist chic aesthetic. Muted-hue designer throw pillows incorporate texture and an irresistibly soft touch. The only problem? Deciding who gets dibs on the generously scaled corner chaise that makes it all too easy to curl up or stretch out.

### SHOP THE COLLECTION



### Option 1

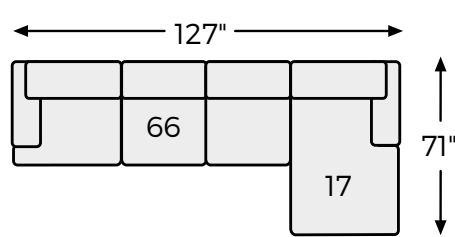

### Option 2

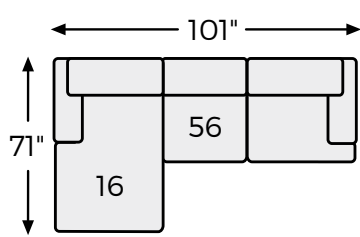

### Option 3

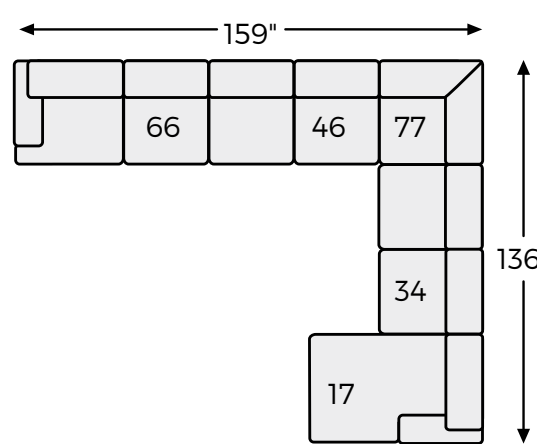

### Option 4

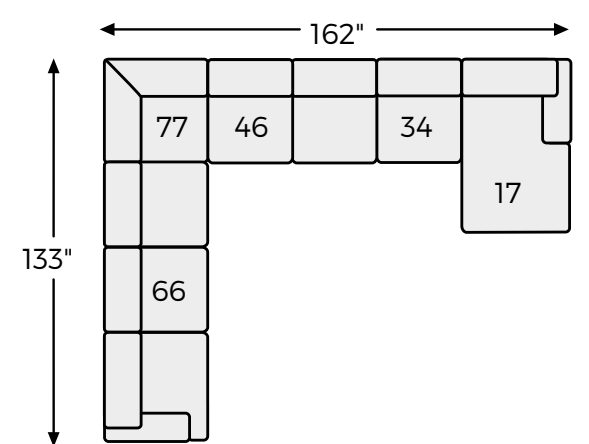

### Option 5

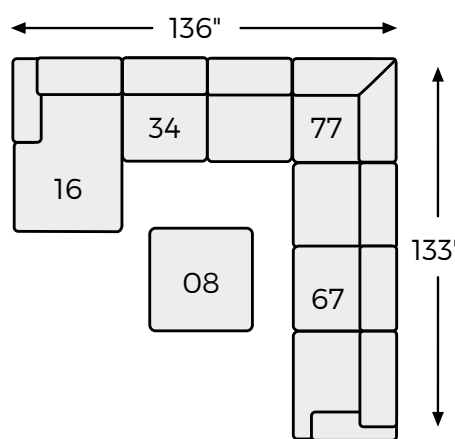

### Option 6

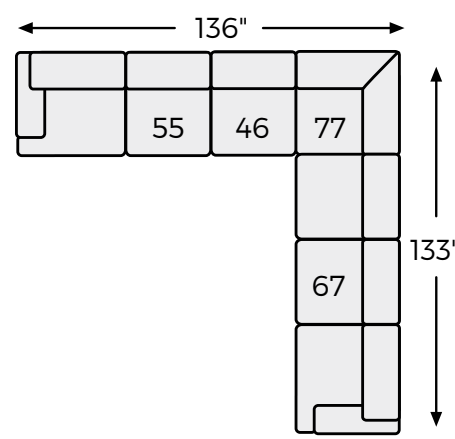

### Option 7

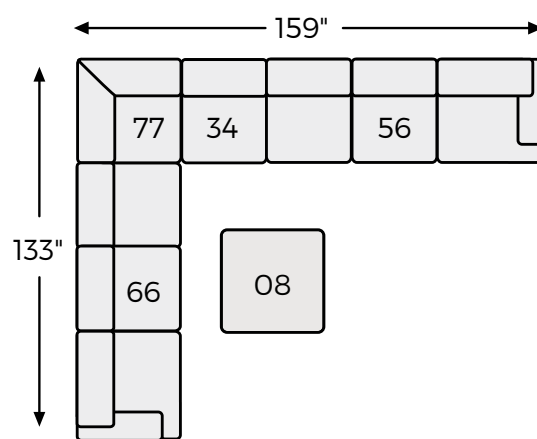

### Option 8

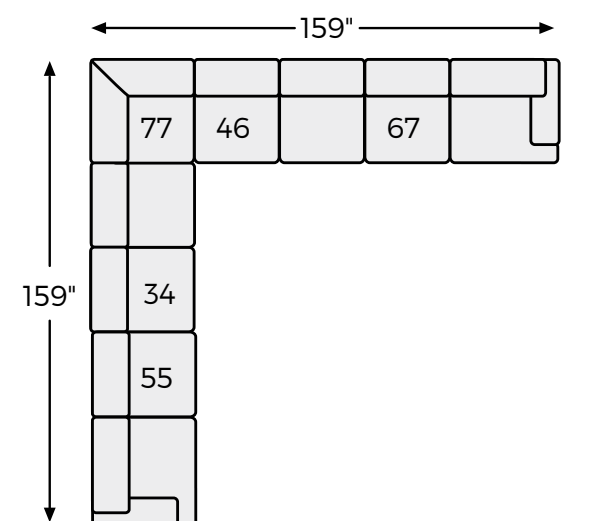

-08 OVERSIZED ACCENT OTTOMAN

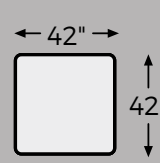

-34 ARMLESS LOVESEAT

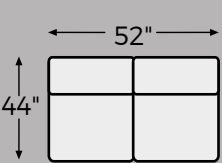

-46 ARMLESS CHAIR

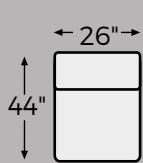

-66 LAF SOFA

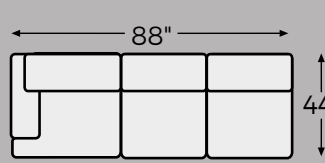

-67 RAF SOFA

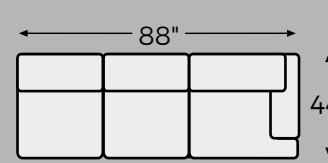

-16 LAF CORNER CHAISE

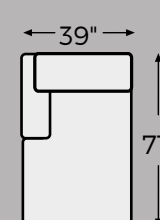

-17 RAF CORNER CHAISE

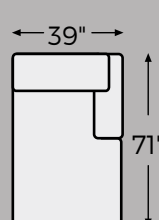

-55 LAF LOVESEAT

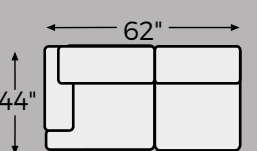

-56 RAF LOVESEAT

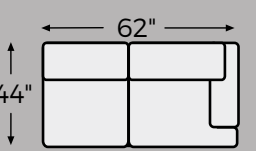

-77 WEDGE

